

**HZ103700TX**

**Boyle Bar Cabinet**

**Assembly Instructions**



**Southern  
ENTERPRISES**



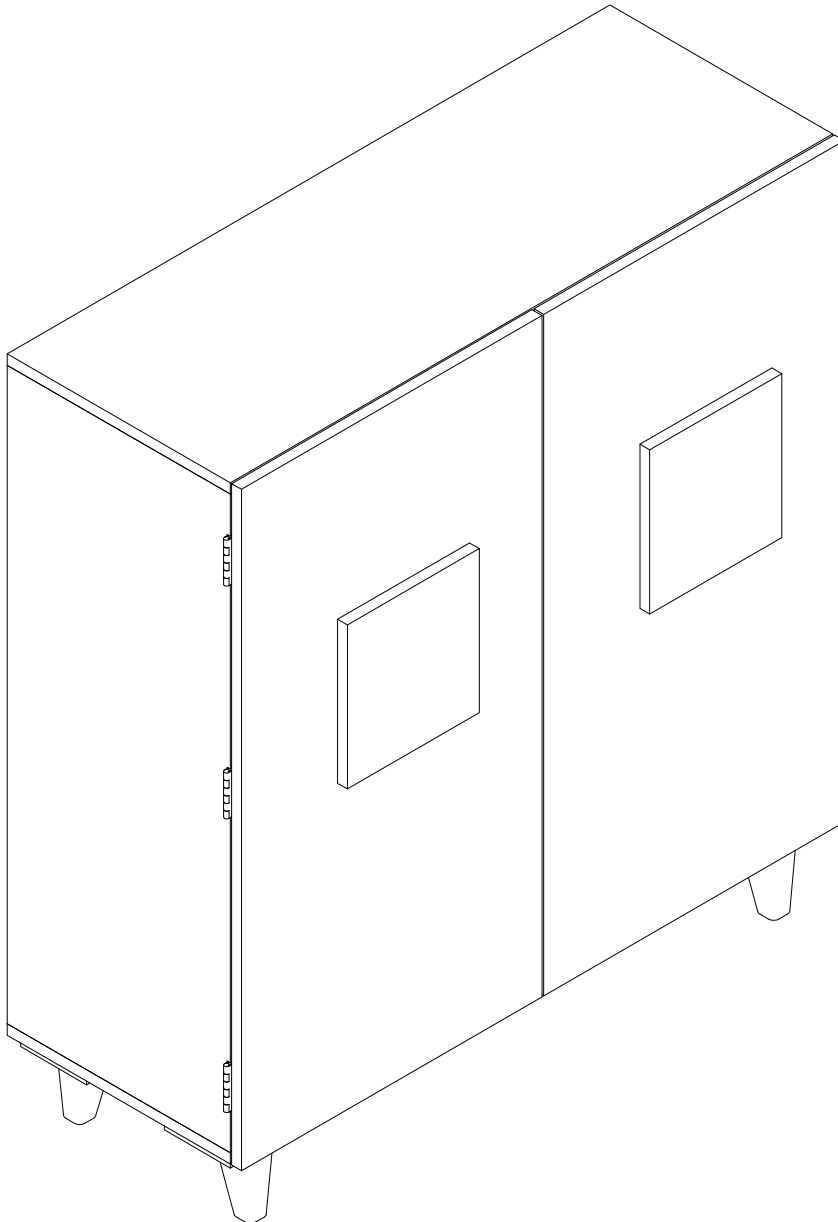

For assistance with assembly, contact:  
Southern Enterprises Inc.  
Customer Service 1-800-633-5096  
[service@seidal.com](mailto:service@seidal.com)  
[www.seidal.com](http://www.seidal.com)





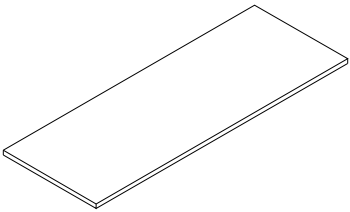
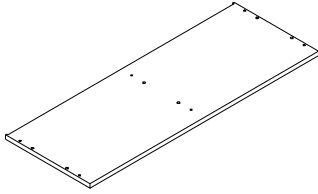
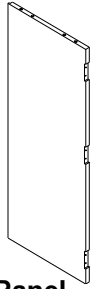

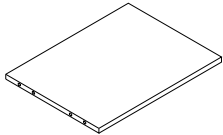
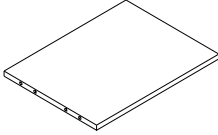
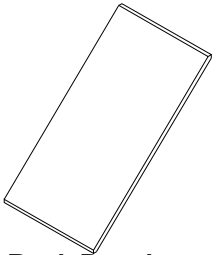
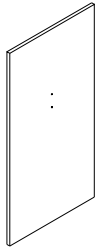
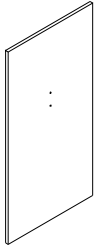
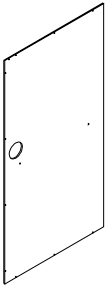



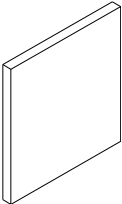
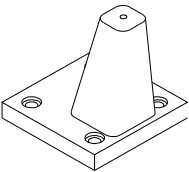
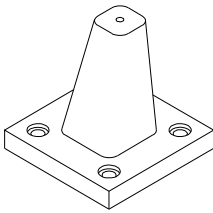

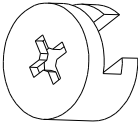
# Boyle Bar Cabinet

## Parts list

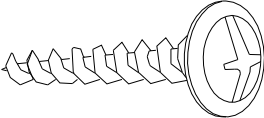
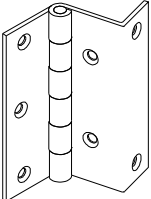
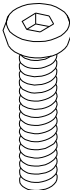
Please check packaging for all parts and hardware before discarding. Unpack and lay parts on clean, padded surface like carpet or blanket. Check that you have all parts indicated. Call customer service if hardware is missing. Before beginning assembly, carefully study the diagrams below and sort your hardware according to the pictures. Using the incorrect hardware will cause damage.

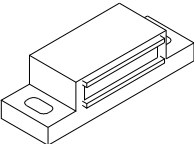
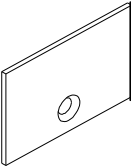
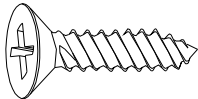
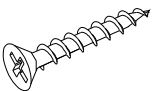
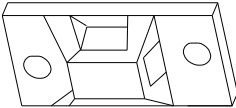
<p><b>A.</b> <span style="float: right;">Quantity of 1</span></p>  <p><b>Top Panel</b></p>	<p><b>B.</b> <span style="float: right;">Quantity of 1</span></p>  <p><b>Bottom Panel</b></p>	<p><b>C.</b> <span style="float: right;">Quantity of 1</span></p>  <p><b>Left Side Panel</b></p>
<p><b>D.</b> <span style="float: right;">Quantity of 1</span></p>  <p><b>Right Side Panel</b></p>	<p><b>E.</b> <span style="float: right;">Quantity of 1</span></p>  <p><b>Middle Vertical Panel</b></p>	<p><b>F.</b> <span style="float: right;">Quantity of 1</span></p>  <p><b>Left Fixed Shelf Panel</b></p>
<p><b>G.</b> <span style="float: right;">Quantity of 1</span></p>  <p><b>Right Fixed Shelf Panel</b></p>	<p><b>H.</b> <span style="float: right;">Quantity of 2</span></p>  <p><b>Wine Rack Panel</b></p>	<p><b>I.</b> <span style="float: right;">Quantity of 1</span></p>  <p><b>Left Door</b></p>
<p><b>J.</b> <span style="float: right;">Quantity of 1</span></p>  <p><b>Right Door</b></p>	<p><b>K.</b> <span style="float: right;">Quantity of 1</span></p>  <p><b>Left Back Panel</b></p>	<p><b>L.</b> <span style="float: right;">Quantity of 1</span></p>  <p><b>Right Back Panel</b></p>

<p><b>M.</b> Quantity of 2</p>  <p><b>Wood Handle</b></p>	<p><b>N.</b> Quantity of 2</p>  <p><b>Front Leg</b></p>	<p><b>O.</b> Quantity of 2</p>  <p><b>Back Leg</b></p>
<p><b>1</b> Quantity of 20</p>  <p><b>Cam Bolt</b></p>	<p><b>2</b> Quantity of 20</p>  <p><b>Cam Lock</b></p>	<p><b>3</b> Quantity of 20</p>  <p><b>Wood Dowel: Dia5/16"x1-1/4"</b></p>
<p><b>4.</b> Quantity of 44</p>  <p><b>Screw: 1/8"x1/2"</b></p>	<p><b>5.</b> Quantity of 4</p>  <p><b>Small Bolt: Dia5/32"x1"</b></p>	<p><b>6.</b> Quantity of 26</p>  <p><b>Screw: 1/8"x5/8"</b></p>
<p><b>7.</b> Quantity of 6</p>  <p><b>Hinge</b></p>	<p><b>8.</b> Quantity of 16</p>  <p><b>Bolt: 5/16"x1"</b></p>	<p><b>9.</b> Quantity of 1</p>  <p><b>Allen Wrench</b></p>
<p><b>10.</b> Quantity of 2</p>  <p><b>Magnet</b></p>	<p><b>11.</b> Quantity of 2</p>  <p><b>Metal Plate</b></p>	<p><b>12.</b> Quantity of 4</p>  <p><b>Screw: 1/8"x5/8"</b></p>
<p><b>13.</b> Quantity of 4</p>  <p><b>Screw: 1/8"x1-5/8"</b></p>	<p><b>14.</b> Quantity of 4</p>  <p><b>Brackets</b></p>	<p><b>15.</b> Quantity of 2</p>  <p><b>Plastic Straps</b></p>

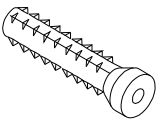
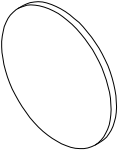
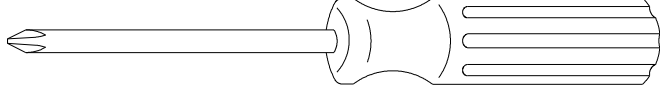
<p><b>16.</b></p> <p>Quantity of 4</p>  <p><b>Plastic Anchor</b></p>	<p><b>17.</b></p> <p>Quantity of 20</p>  <p><b>Covers</b></p>	
<p><b>Care and Cleaning Instructions:</b>          Before using, wipe with a clean, dry cloth.          Periodically apply furniture wax to renew the finish. Avoid rubbing or scratching the surface with rough or abrasive objects.</p>		<p>Call customer service at 1-800-633-5096 for assistance, questions, or Parts.</p>
<p><b>Assembly Tool Required No.2 Phillips Screwdriver (Not included)</b></p>		

**Tool List: 3/16" Drill Bit, Drill, Tape Measure and Pencil.**

# Boyle Bar Cabinet

## Assembly Instructions

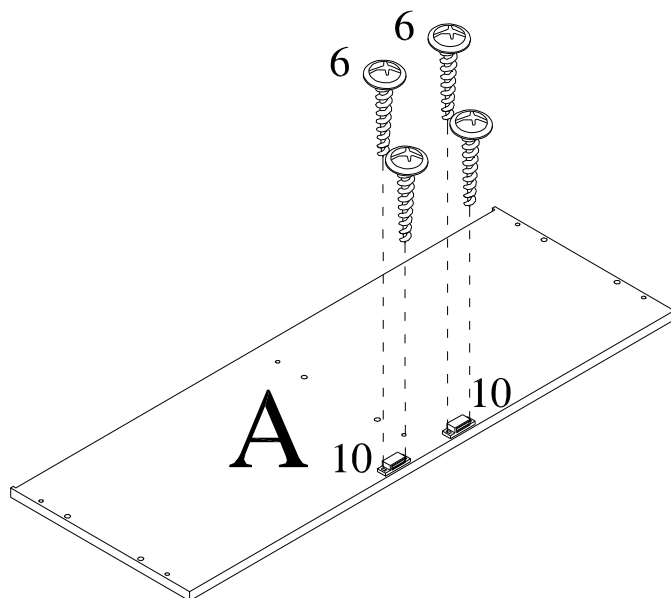

Attach Magnets (10) to Top Panel (A) with Screw (6).

Tighten Screws with Phillips screwdriver.

Figure 1

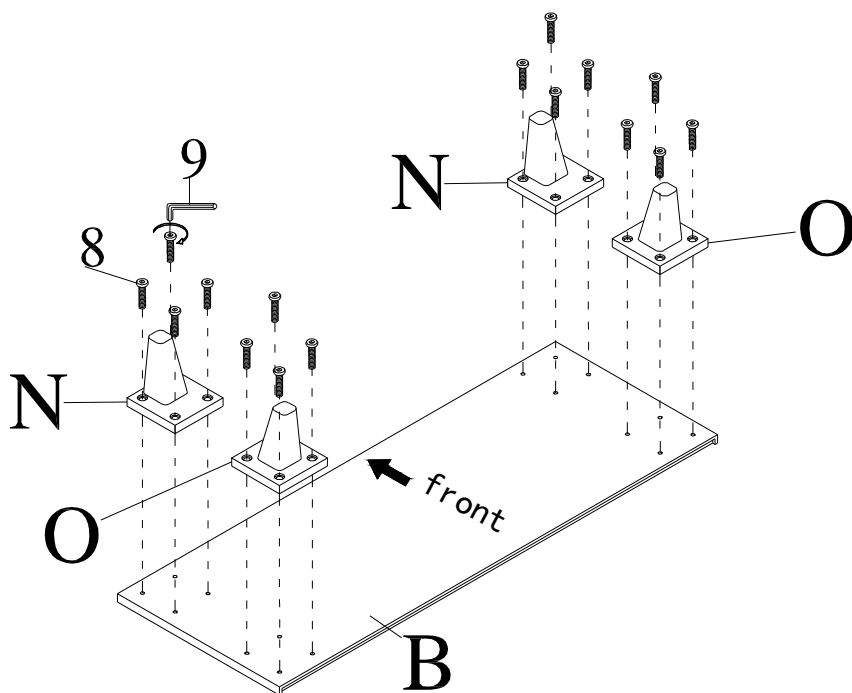

Distinguish which side is the front of Bottom Panel (B).

Attach Front Legs (N) towards the front of Bottom Panel (B) and the Back Legs (O) towards the rear with Bolt (8).

Tighten bolts with Allen Wrench (9).

**Notice: Each Leg has a slight taper. Make sure the Front Legs (N) are tapered towards the front of the Bottom Panel (B) while the Back Legs (O) are tapered towards the rear.**

Figure 2

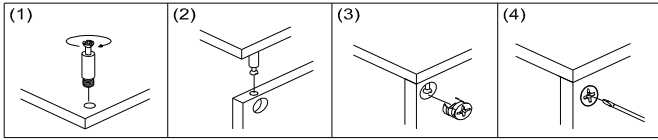

"Please do not over tighten cambolts. Please stop when you feel tight"

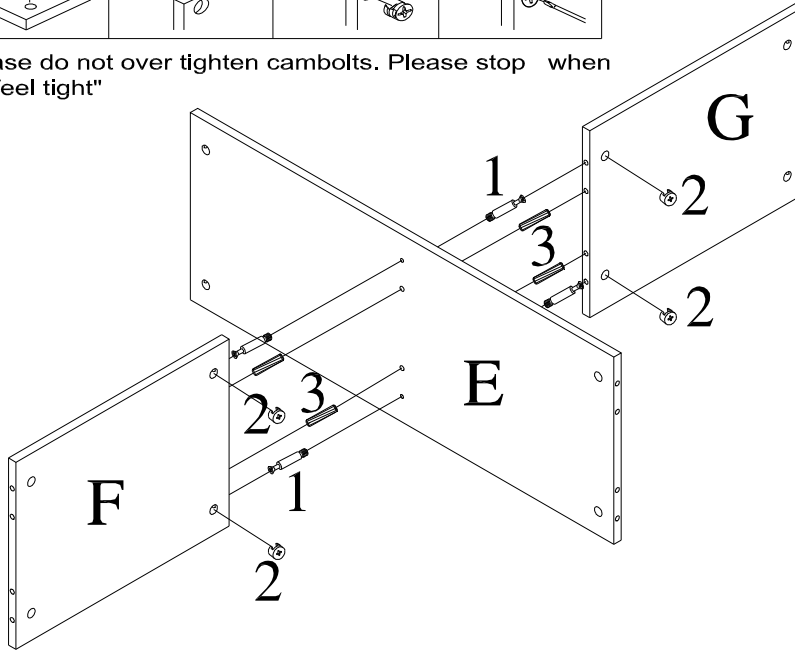

Insert Cam Locks (2) into corresponding holes on Left Fixed Shelf Panel (F) and Right Fixed Shelf Panel (G).

Screw Cam Bolts (1) into threaded holes and insert Wood Dowels (3) into both sides of Middle Vertical Panel (E).

Attach Left Fixed Shelf Panel (F) and Right Fixed Shelf Panel (G) to Middle Vertical Panel (E) by inserting Wood Dowels (3) and Cam Bolts (1) into corresponding holes until panels meet.

Tighten Cam Locks (2) by rotating clockwise with Phillips screwdriver.

Figure 3

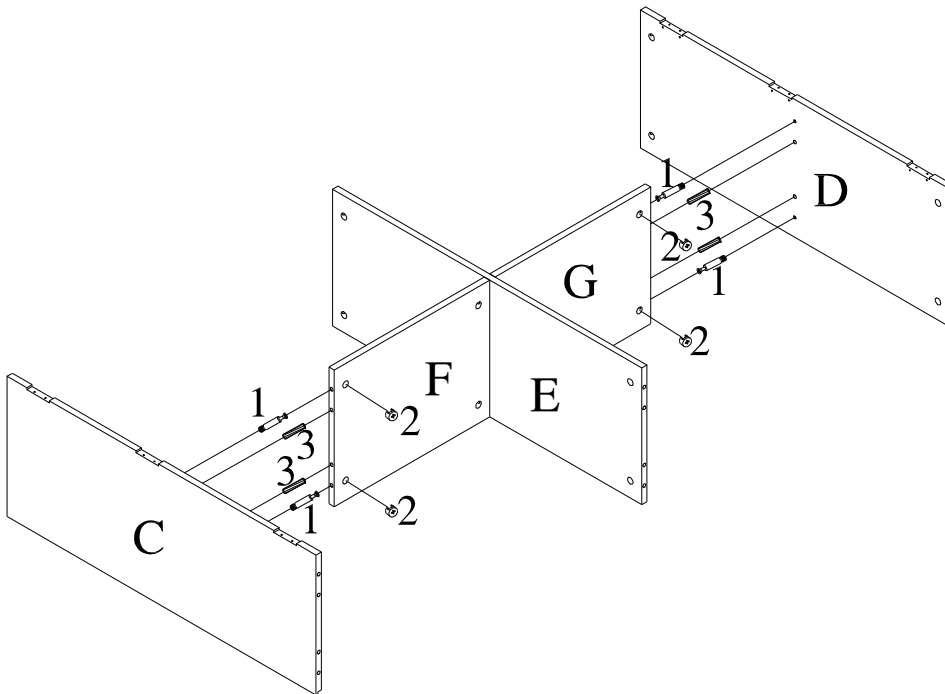

Insert Cam Locks (2) into corresponding holes on the assembled unit from Figure 3.

Screw Cam Bolts (1) into threaded holes on Left Side Panel (C) and Right Side Panel (D). Then, insert Wood Dowels (3) into the corresponding holes between the Cam Bolts.

Attach Left Side Panel (C) and Right Side Panel (D) to the assembled unit from Figure 3 by inserting Wood Dowels (3) and Cam Bolts (1) into corresponding holes until panels meet.

Tighten by rotating Cam Locks (2) clockwise with Phillips screwdriver.

Figure 4

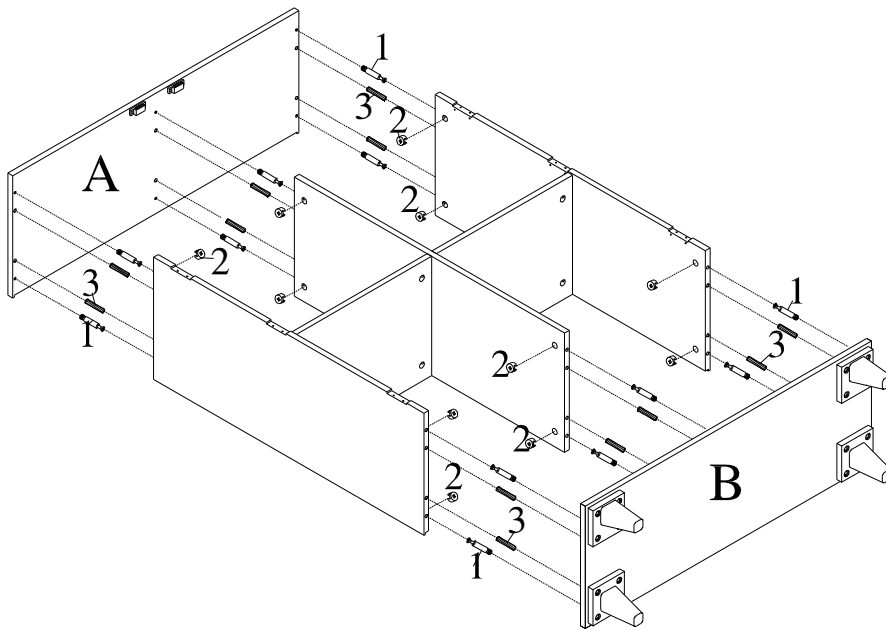

Insert Cam Lock (2) into the corresponding holes on the assembled unit from Figure 4.

Screw Cam Bolts (1) into threaded holes on Top Panel (A) and Bottom Panel (B). Then, insert Wood Dowels (3) into the corresponding holes between the Cam Bolts.

Attach the assembled unit from Figure 4 to Top Panel (A) and Bottom Panel (B) by inserting Wood Dowels (3) and Cam Bolts (1) into corresponding holes until panels meet.

Tighten by rotating Cam Locks (2) clockwise with Phillips screwdriver.

**Figure 5**

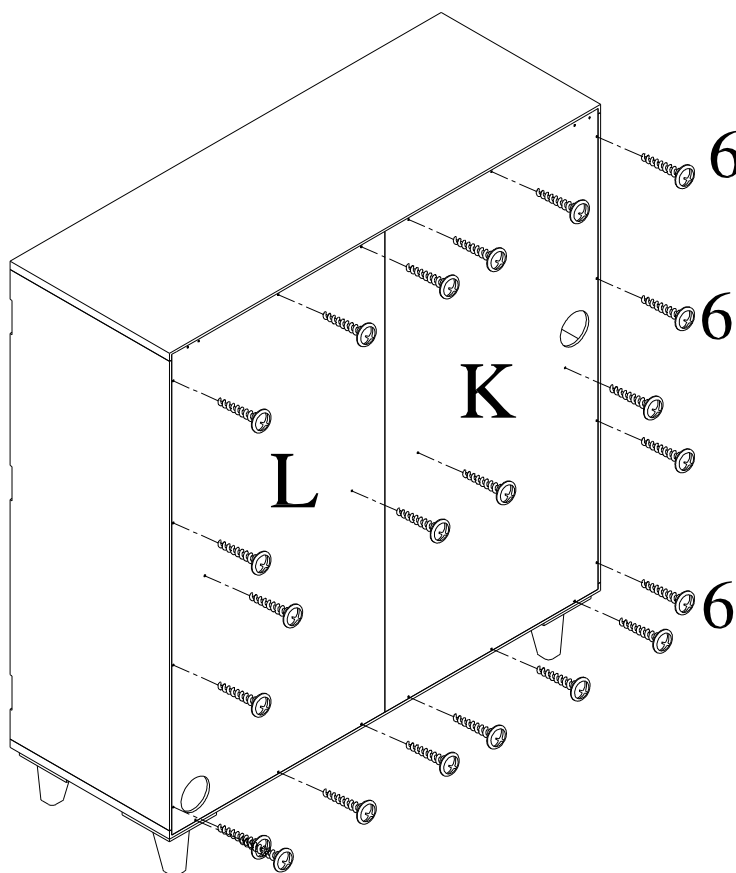

Attach Back Panels (L/K) to the assembled unit Screws (6).

Tighten screws with Phillips screwdriver.

**Figure 6**

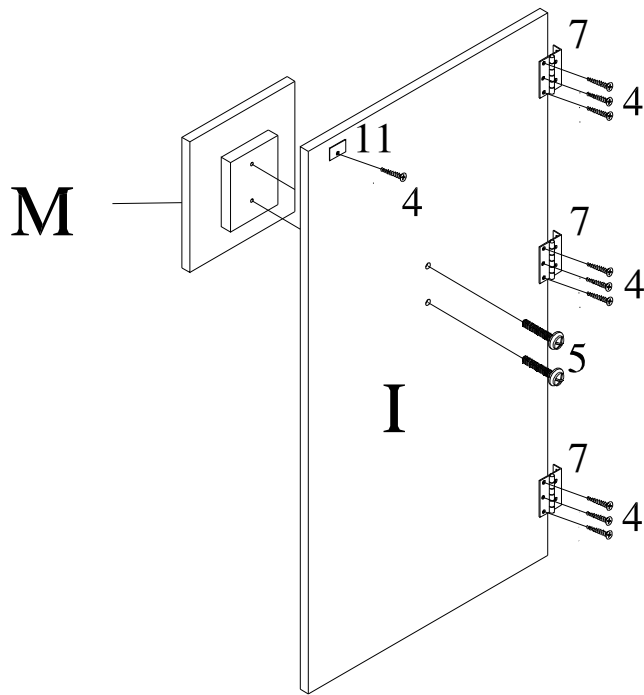

Attach Hinges (7) and Metal Plates (11) to Left Door (I) with Screws (4).

Attach Wood Handle (M) to Left Door (I) with Bolts (5).

Tighten bolts and screws with Phillip screwdriver.

Figure 7

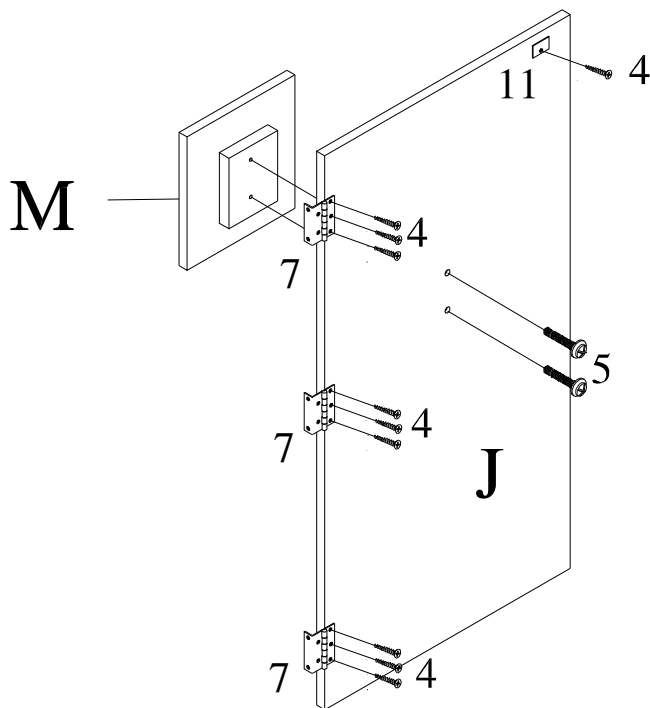

Attach Hinges (7) and Metal Plates (11) to Right Door (J) with Screws (4).

Attach Wood Handle (M) to Right Door (J) with Bolts (5).

Tighten bolts and screws with Phillip screwdriver.

Figure 8



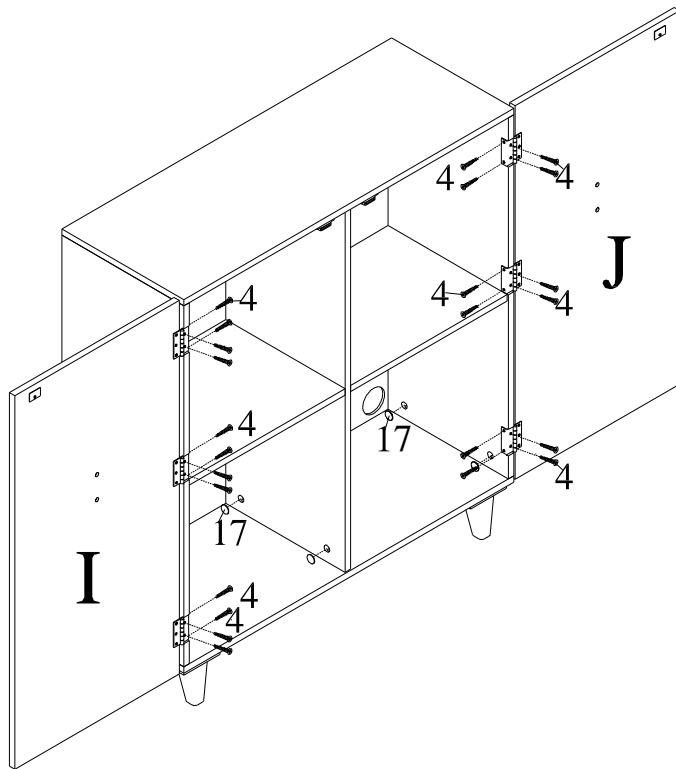

Attach Doors (**I/J**) to the assembled unit with Screws (**4**).

Tighten screws with Phillips screwdriver.

Cover all cam lock holes with Covers (**17**).

**Figure 9**

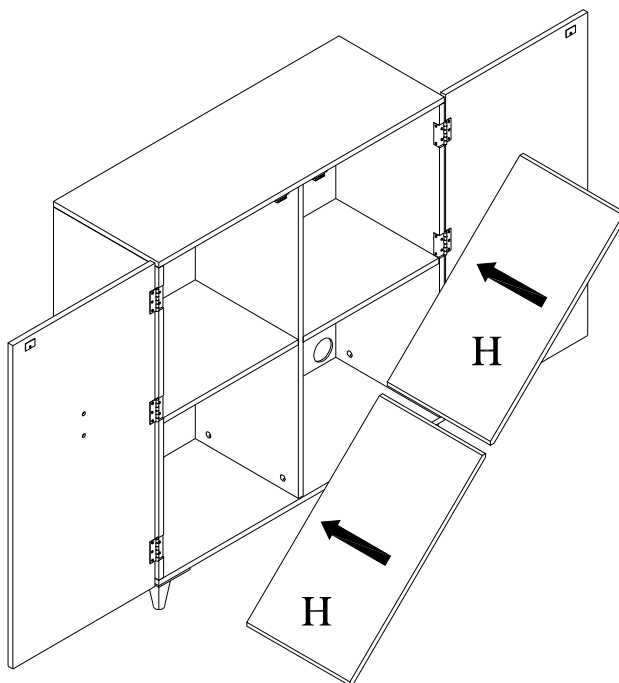

Insert Wine Rack Panels (**H**) into the assembled unit as shown.

**Figure 10**

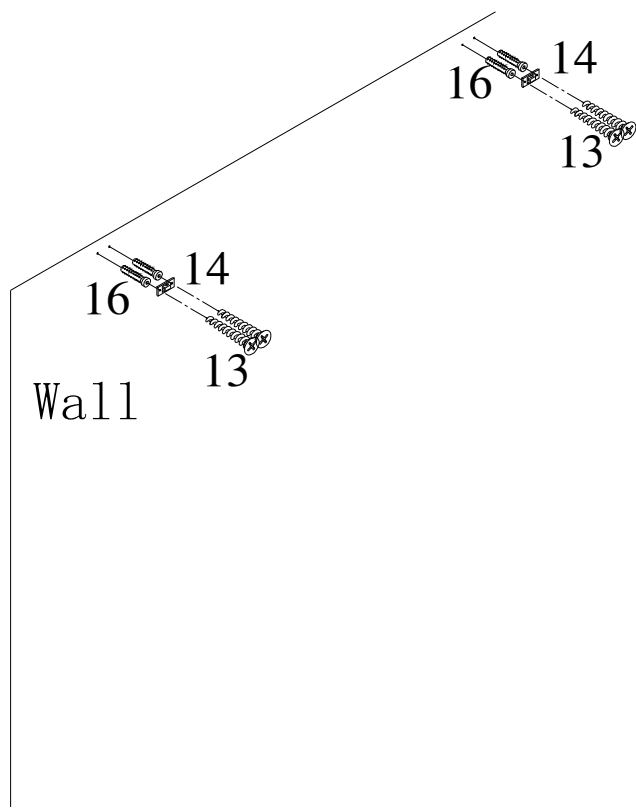

Mark two desired locations on wall. Drill two 3/16" holes on wall for each Bracket (14) matching the distance of the Brackets installed to the back of the unit (see Figure 11).

Insert Plastic Anchors (16) into the holes on wall as shown. (When doing this, you will need a hammer help you).

Then, attach the Brackets (14) to wall using Screws (13).

Tighten Screws (13) using Philips screwdriver.

Figure 11

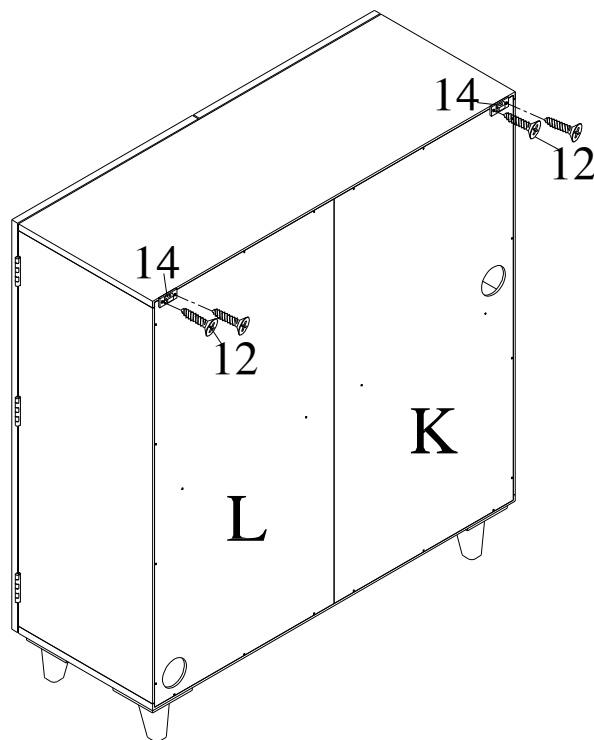

Attach Brackets (14) to Back Panels using Screws (12).

Tighten Screws (12) using Philips screwdriver.

Figure 12

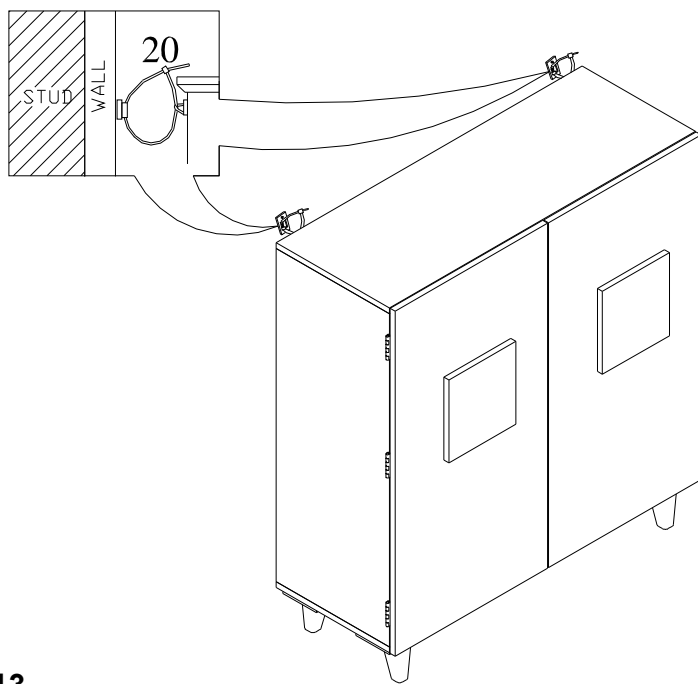

Move the unit close to the wall Brackets (14) and tie both Brackets (14) with Plastic Straps (20) as shown in diagram.

Adjust the adjustable levels on the feet to keep the unit stable

**Anti-tipping hardware must be used for this product to avoid tipping and injury.**

Now you Boyle bar cabinet is ready for use!

**Figure 13**

## Parts Replacement Form

### Customer Information

Name \_\_\_\_\_

Address \_\_\_\_\_

City/State/Zip Code \_\_\_\_\_

Phone Number \_\_\_\_\_

Please indicate where you purchased this item: Store/Website/Catalog

\_\_\_\_\_

Please indicate color/size/style number:

\_\_\_\_\_

Style No	Parts Letter	Parts Description	Quantity Needed
_____	_____	_____	_____
_____	_____	_____	_____
_____	_____	_____	_____

Please immediately examine this product carefully. Any request for missing parts or damage replacement must be received within 90 days of your receipt of the product. Replacement, if available, will be honored within this time frame. Parts will not be available for items arriving fully assembled. We do not recommend modifying product(s) and we are not responsible for any damages due to product modification(s). If damages or missing parts are not reported within 90 days of your receipt, we are under no obligation to provide parts or replacement merchandise.

Please contact Southern Enterprises at 800-633-5096 or in Dallas 972-869-0111/ 9am – 4pm Mon-Fri Central time if you have product issues or email us at [service@seidal.com](mailto:service@seidal.com). Please ask for customer service representative for issues involving damages or replacement parts. Please ask for technical assistance representative for any issues with product and assembly/construction.

Please contact the retailer that you purchased from for returns.



**Southern**  
**ENTERPRISES**

For assistance with assembly,  
contact:  
Southern Enterprises Inc.  
Customer Service 1-800-633-5096  
[service@seidal.com](mailto:service@seidal.com)  
[www.seidal.com](http://www.seidal.com)