

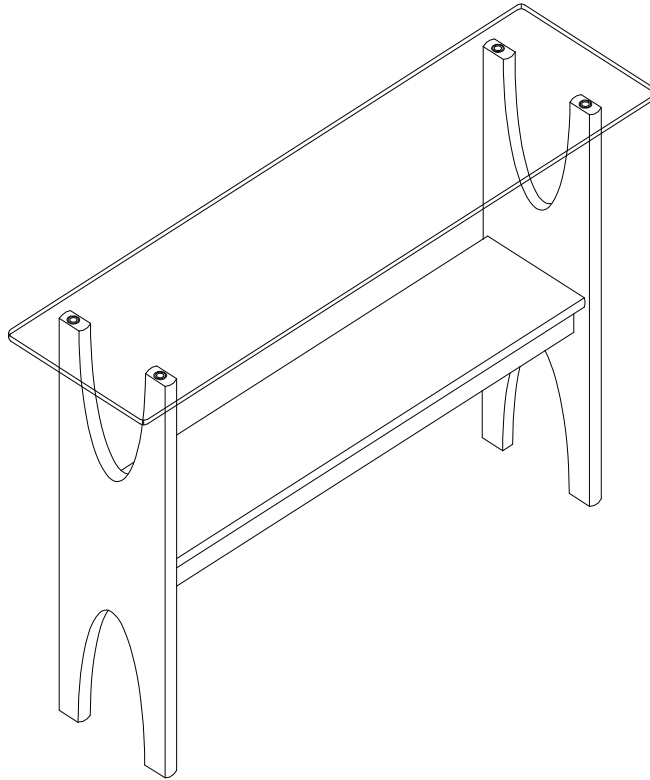

PO#

800.633.5096  
service@seidal.com



Item #

Número de artículo

Numéro de l'article

CK177300TX

CK177300TX

CK177300TX

**Thanks!**

Thank you for your purchase. Our products offer a limited 1-year warranty and feature the latest trends and design styles.

**¡Gracias!**

Gracias por su compra. Nuestros productos vienen con una garantía limitada de 1 año y le ofrecen lo último en tendencias y estilos.

**Merci!**

Merci de votre achat. Nos produits sont offerts avec une garantie limitée de 1 an et proposent les plus récents styles et tendances en matière de conception.

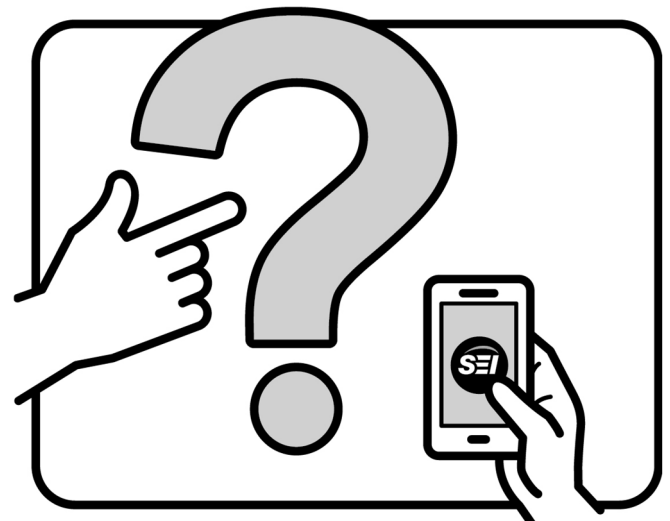
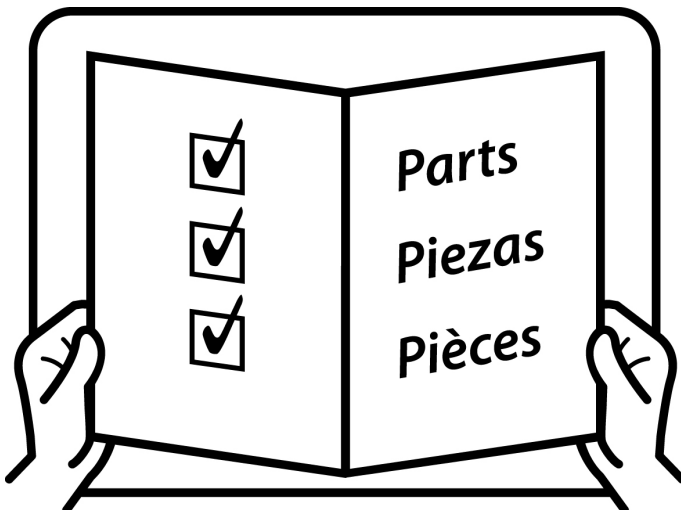
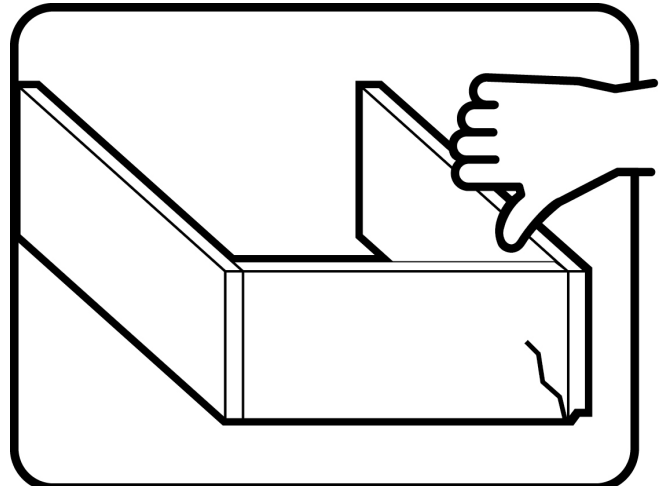
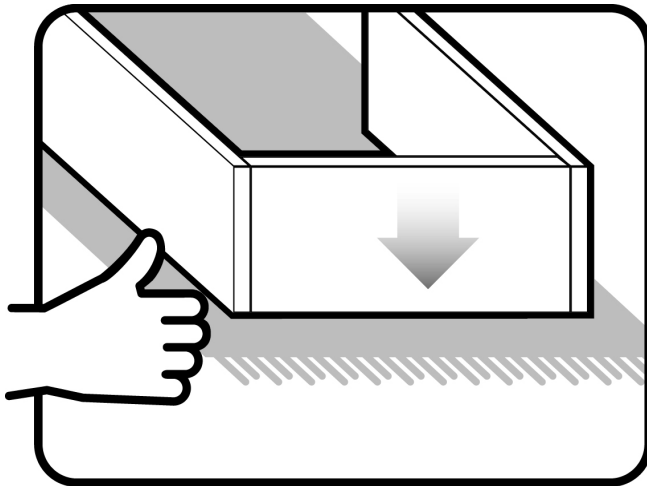
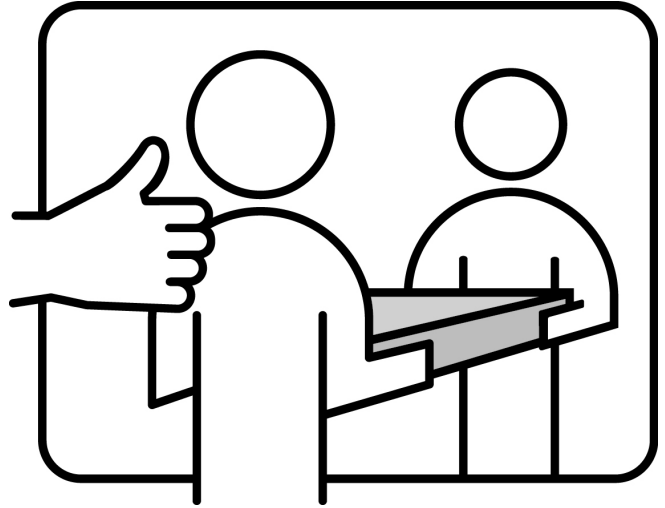
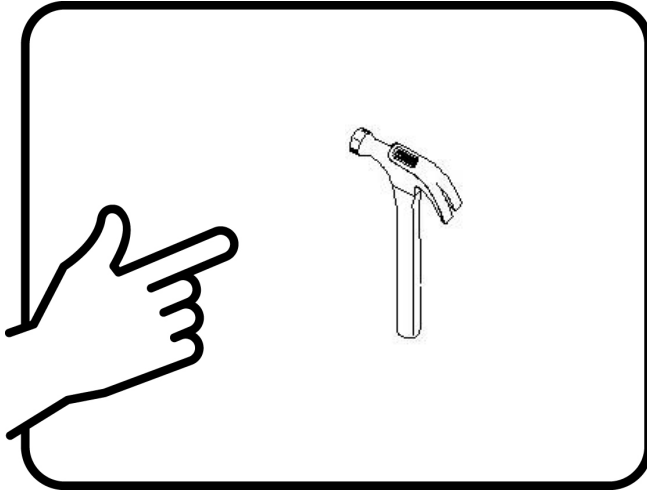

Techniques | Técnicas | Techniques

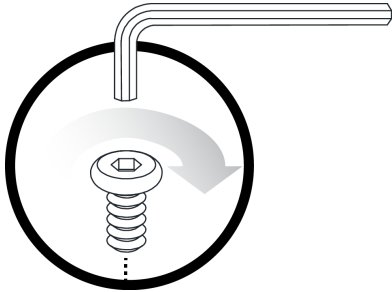

Care | Cuidado | Entretien

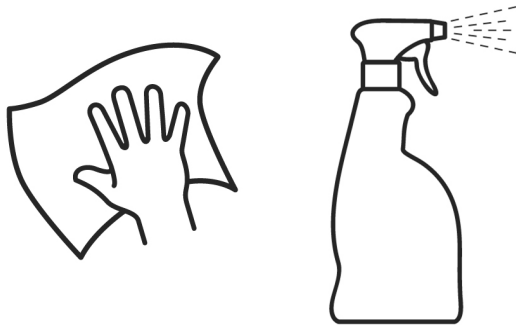



Assembly Help | Ayuda de montaje | Aide à l'assemblage

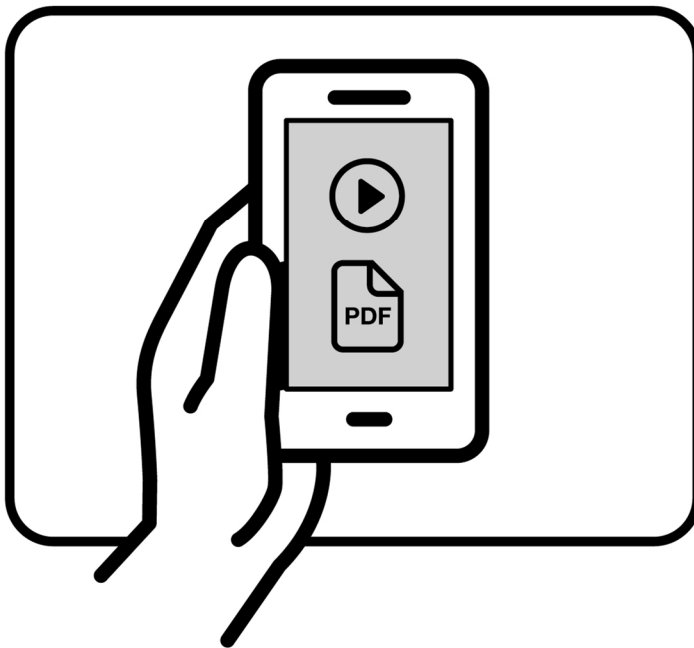
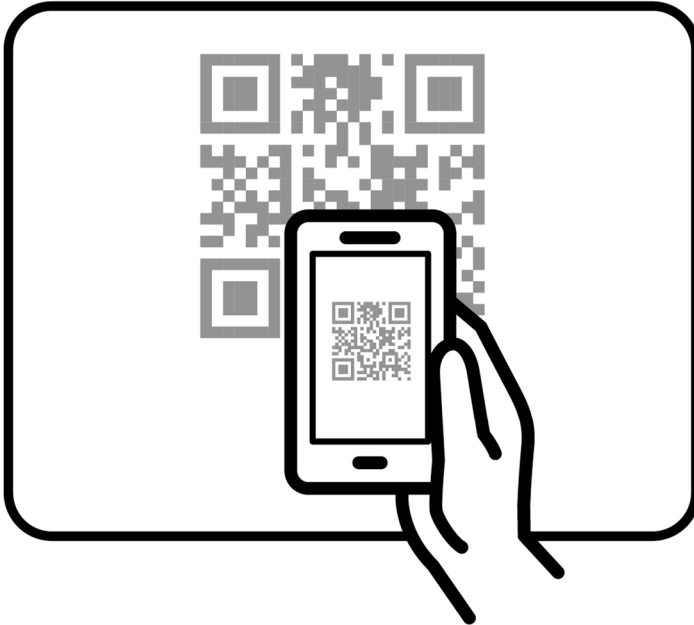

Safety | Seguridad | Sécurité



Note! | Nota: | Remarque!



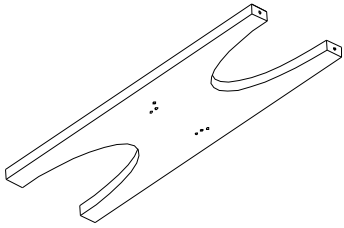

A  
x2

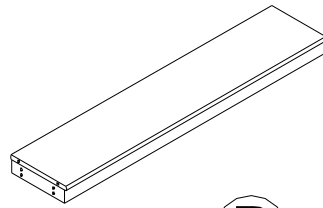

B  
x1

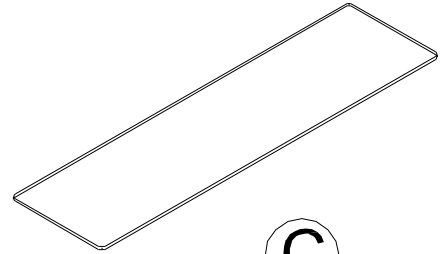

C  
x1

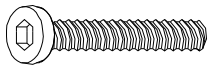

1  
x8



2  
x4

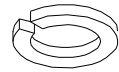

3  
x8

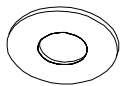

4  
x8



5  
x1

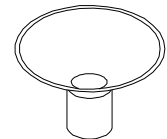

6  
x4



1

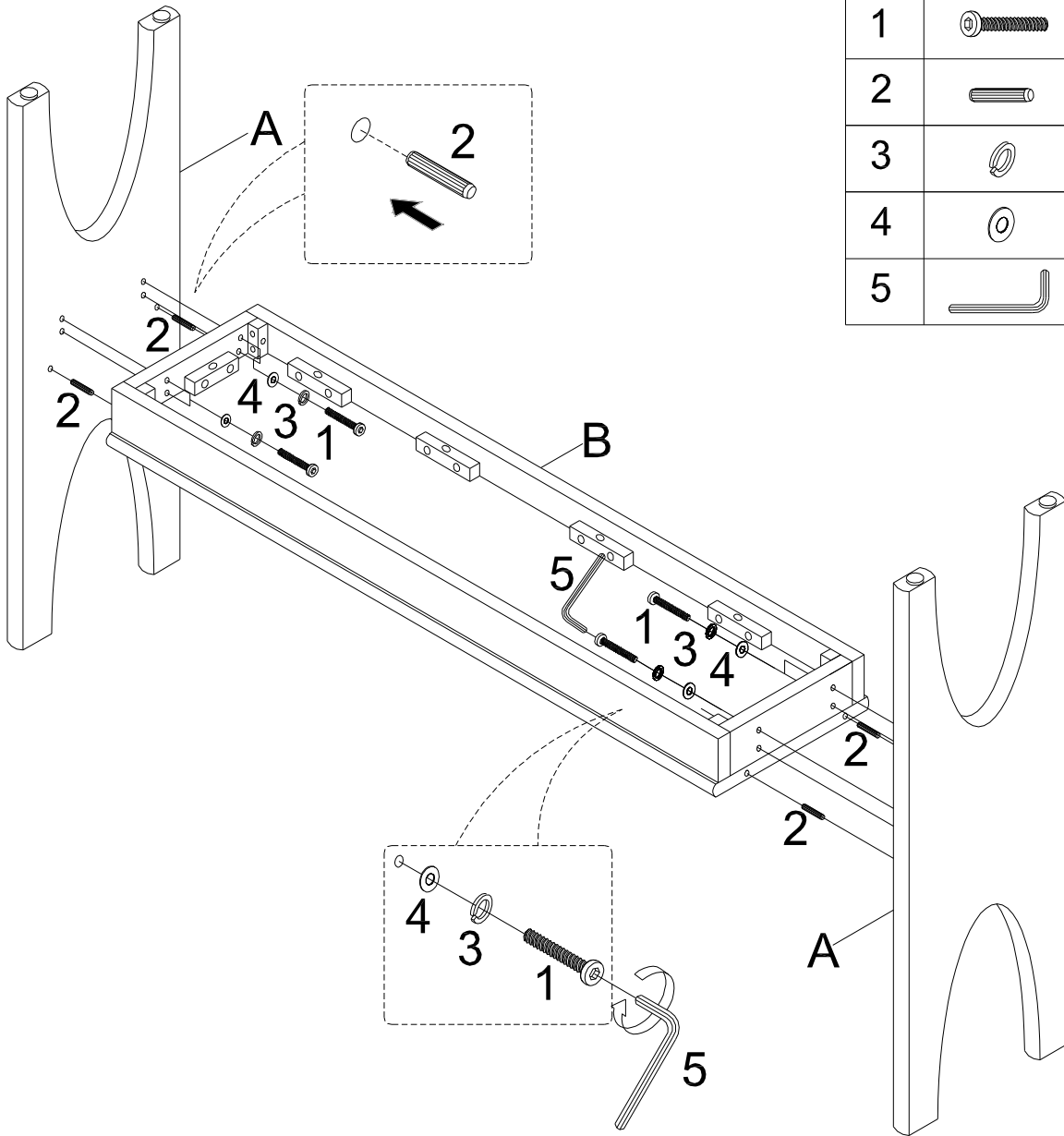

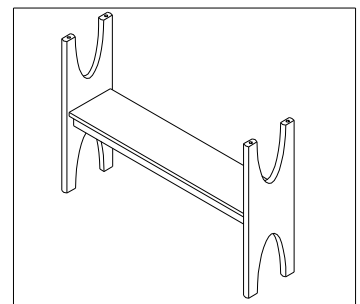

1		x 8
2		x 4
3		x 8
4		x 8
5		x 1



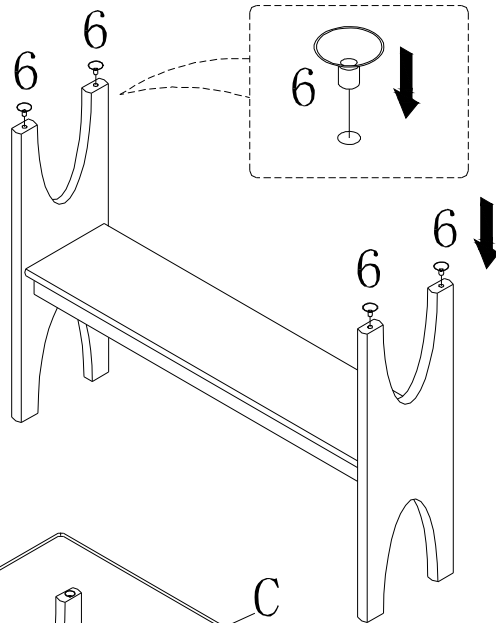

2



6		x 4
---	---	-----

3

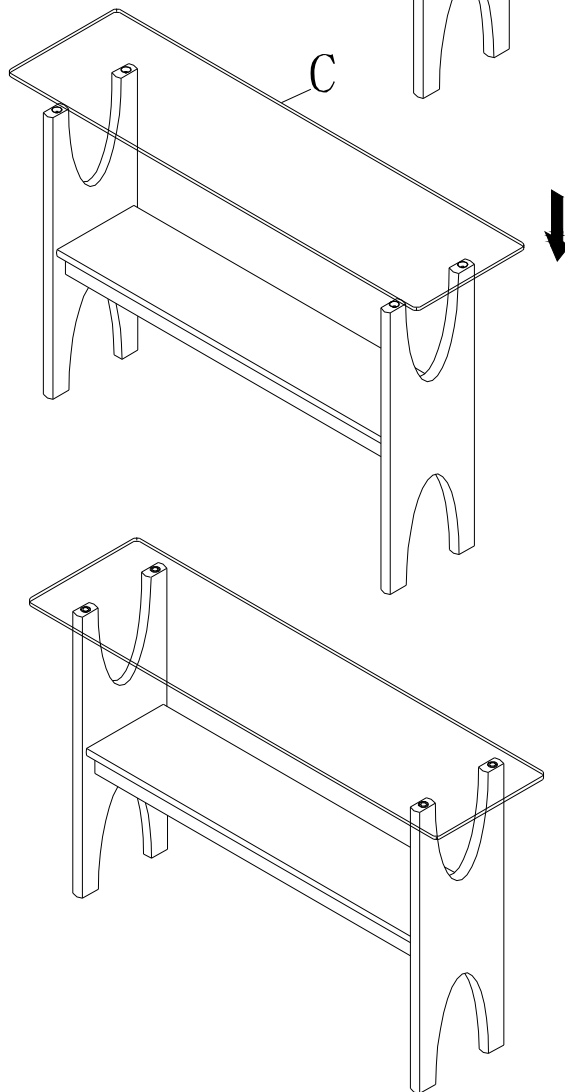



**Congratulations! | ¡Felicitaciones! | Félicitations!**

Share Your Thoughts | Queremos conocer su opinión | Partagez vos impressions

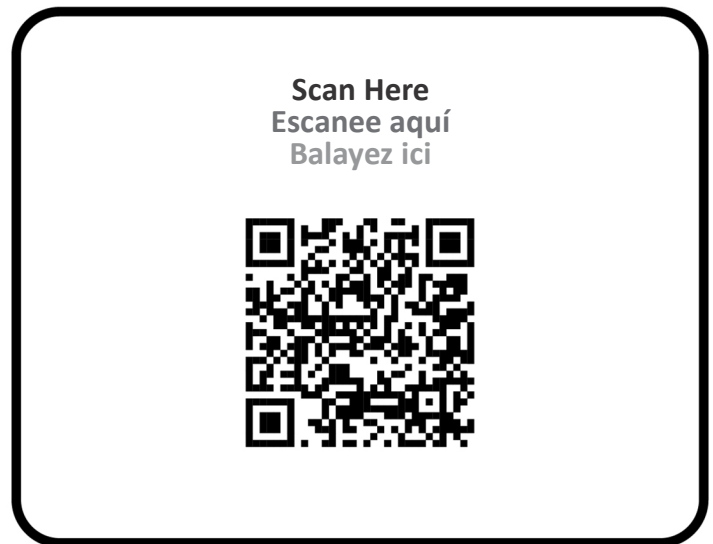
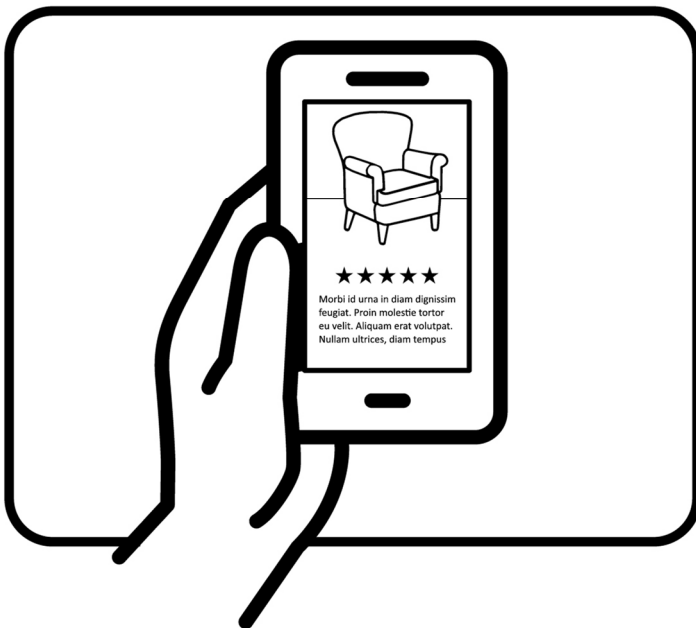
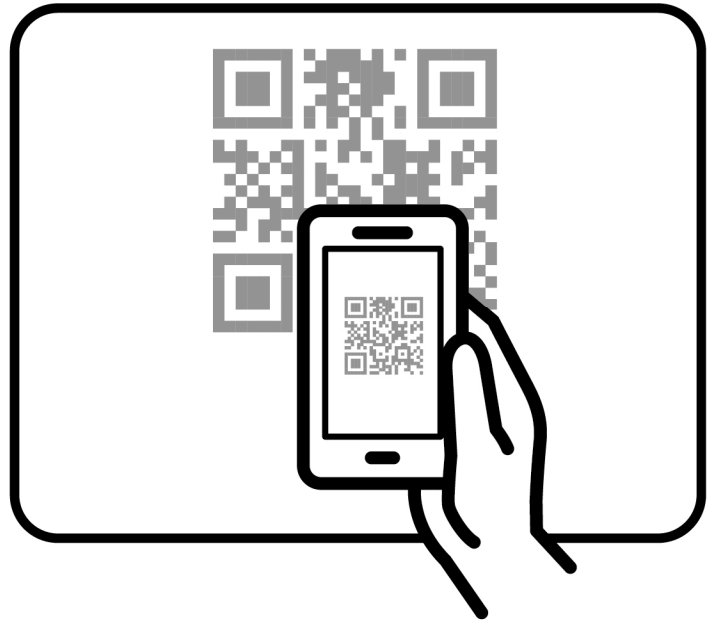
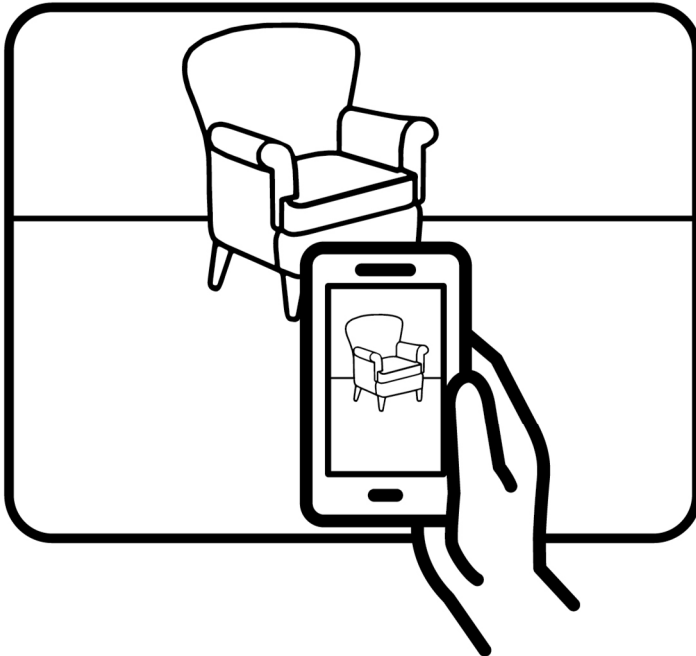





## May We Help You?

**800.633.5096**

Have these ready when you call:

- Item Number
- PO #
- Purchaser Name
- Place of Purchase

Please immediately examine this product carefully. Any request for missing parts or damage replacement must be received within 90 days of your receipt of the product. Replacement, if available, will be honored within this time frame. Parts will not be available for items arriving fully assembled. We do not recommend modifying product(s) and we are not responsible for any damages due to product modification(s). If damages or missing parts are not reported within 90 days of your receipt, we are under no obligation to provide parts or replacement merchandise. For product issues, please contact Southern Enterprises at 800-633- 5096 (toll-free) / 972-869-0111 (Dallas) Mon-Fri 9am – 4pm CST, or email us at [service@seidal.com](mailto:service@seidal.com). Please ask for customer service representative for issues involving damages or replacement parts. Please ask for technical assistance representative for any issues with product and assembly/ construction. Please contact the retailer that you purchased from for returns.

## ¿Podemos ayudarle?

**800.633.5096**

Cuando llame, tenga a mano lo siguiente:

- Número de artículo
- N.º de orden de compra
- Nombre del comprador
- Lugar de compra

Revise cuidadosamente este producto de inmediato. Toda solicitud de piezas faltantes o de reemplazo por daños deberá recibirse en nuestras oficinas en un plazo de 90 días desde la fecha en que usted reciba el producto. Si lo hay disponible, se le proporcionará un reemplazo dentro de este período. No habrá piezas disponibles para artículos que lleguen completamente armados. No recomendamos modificar los productos y no asumimos responsabilidad alguna por cualquier daño debido a la modificación de los mismos. Si no informa sobre daños o piezas faltantes en un plazo de 90 días desde la recepción, no asumimos obligación alguna de proporcionar piezas o mercancía de reemplazo. En caso de problemas con los productos, comuníquese con Southern Enterprises al 800-633- 5096 (número gratuito) / 972-869-0111 (Dallas) de lunes a viernes entre las 9 a.m. y las 4 p.m., hora normal del Centro, o envíenos un correo electrónico a [service@seidal.com](mailto:service@seidal.com). En caso de problemas que involucren daños o piezas de reemplazo, pida hablar con un representante de servicio al cliente. En caso de problemas con el armado y/o la construcción, pida hablar con un representante de asistencia técnica. En caso de devoluciones, comuníquese con la tienda donde efectuó la compra.

## Pouvons-nous vous aider?

**800.633.5096**

Ayez les renseignements suivants en main quand vous appelez :

- Numéro de l'article
- Numéro du bon de commande (BC)
- Nom de l'acheteur
- Lieu d'achat

Veillez examiner immédiatement ce produit avec soin. Toute demande de remplacement pour des pièces manquantes ou endommagées doit être reçue dans les 90 jours suivant la réception du produit. Les pièces de remplacement, si elles sont disponibles, seront envoyées dans ce laps de temps. Les pièces ne seront pas disponibles pour les articles qui arrivent entièrement assemblés. Nous ne recommandons pas la modification des produits et nous ne sommes pas responsables des dommages causés par une modification. Si des dommages ou des pièces manquantes ne sont pas signalés dans les 90 jours suivant la réception, nous ne sommes pas tenus de fournir des pièces ou des marchandises de remplacement. Pour toute question sur les produits, veuillez prendre contact avec Southern Enterprises au 800 633-5096 (sans frais) ou au 972 869-0111 (Dallas) du lundi au vendredi de 9 h à 16 h HNC, ou par courriel à [service@seidal.com](mailto:service@seidal.com). Demandez à parler à un représentant du service à la clientèle pour les questions concernant les dommages ou les pièces de remplacement. Demandez un représentant de l'assistance technique pour les problèmes avec le produit et l'assemblage ou la construction. Pour un retour, veuillez prendre contact avec le détaillant où vous avez acheté le produit.